

FEATURES

- 2.5V~5.5V Power supply.
- Thermal shutdown Protection.
- Low current shutdown mode
- No capacitors and networks or bootstrap capacitors required
- Low noise during turn-on and turn-off transitions
- Lead free and green package available. (RoHS Compliant)
- Space Saving Package
 - 8-pin MSOP package.
 - 8-pin DFN Package

APPLICATION

- Portable electronic devices
- Mobile Phones
- PDAs

GENERAL DESCRIPTION

The LY8891 is a 1.0W audio power amplifier. It is capable of driving 8Ω speaker load at a continuous average output of 1.0W/1% distortion (THD+N) from a 5.0V power supply. The LY8891 primarily designed for high quality application in other portable communication device. And the LY8891 audio amplifier features low power consumption shutdown mode. It is achieved by driving the shutdown pin with logic low. And the LY8891 has an internal thermal shutdown protection feature. The LY8891 audio amplifier was designed specifically to provide high quality output power with a minimal amount of external components. The LY8891 does not require output capacitors, and the LY8891 is ideally suited for other low voltage applications or portable electronic devices where minimal power consumption is a primary requirement.

PIN CONFIGURATION

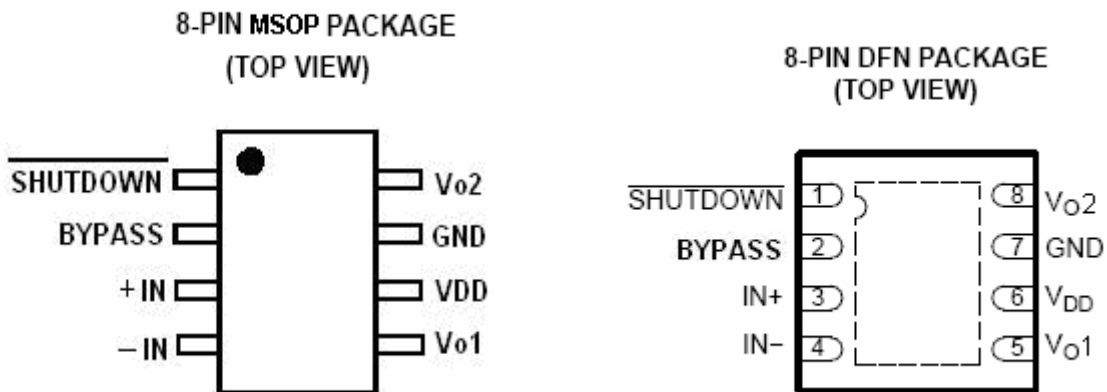

PIN DESCRIPTION

SYMBOL	Pin No.		DESCRIPTION
	MSOP	DFN	
SHUTDOWN	1	1	Shutdown the device.(when low level is active the pin)
BYPASS	2	2	Bypass pin
+IN	3	3	Positive Input
-IN	4	4	Negative Input
Vo1	5	5	Negative output
V _{DD}	6	6	Power Supply
GND	7	7	Ground
Vo2	8	8	Positive Output

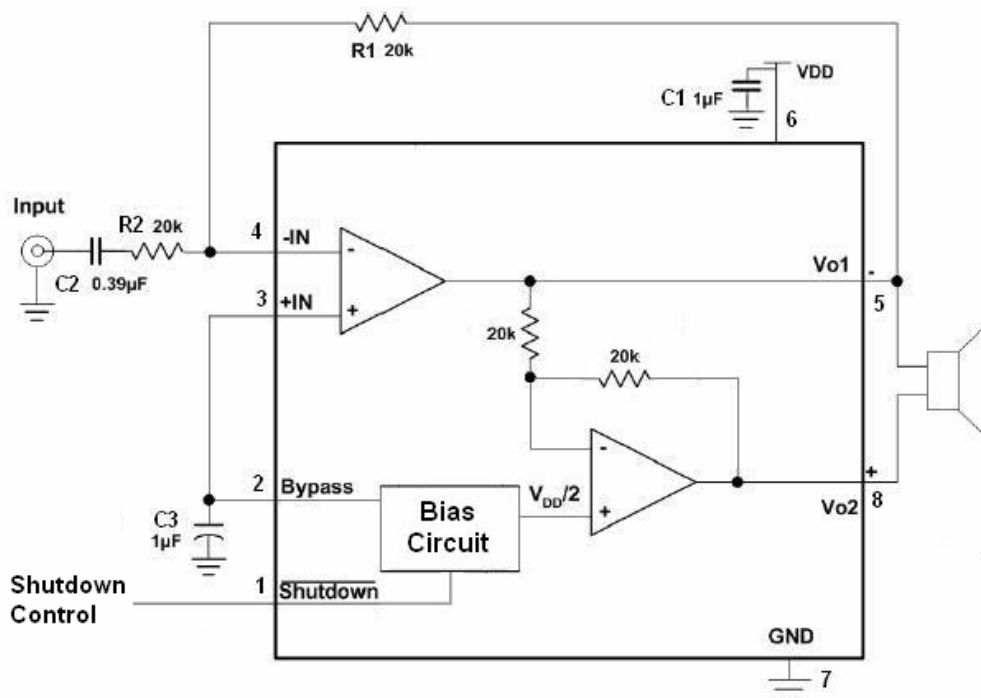
APPLICATION CIRCUIT

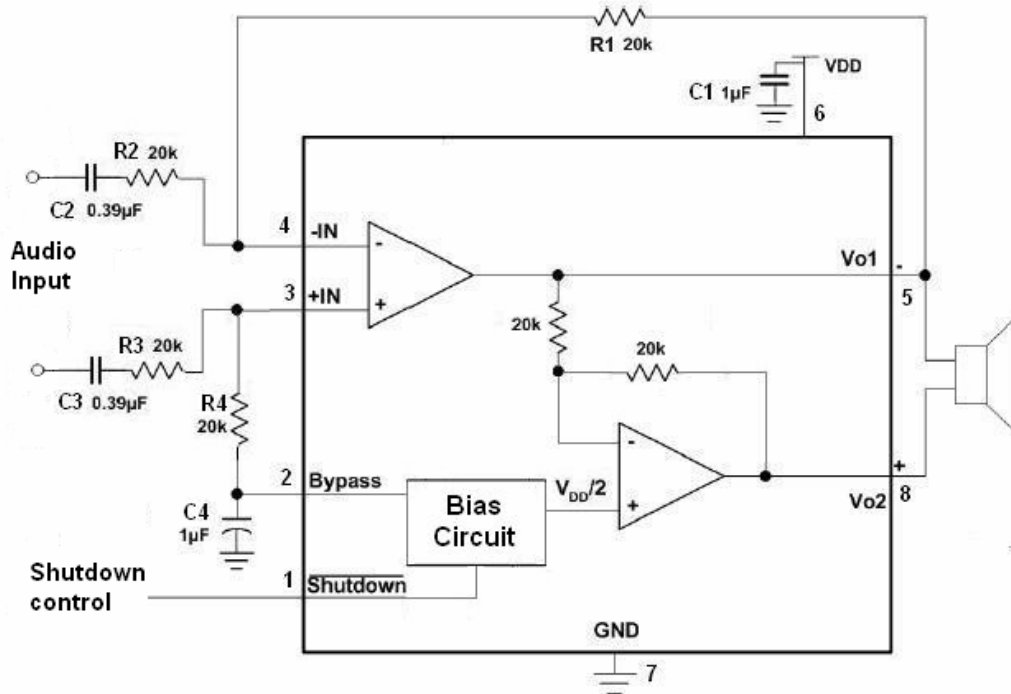
Figure 1. Audio Amplifier with Single –Ended Input

Figure 2. Audio Amplifier with Differential Input
ABSOLUTE MAXIMUM RATINGS*

PARAMETER	SYMBOL	RATING	UNIT
Supply Voltage	V _{DD}	6.0	V
Operating Temperature	T _A	-40 to 85 (I grade)	°C
Input Voltage	V _I	-0.3V to V _{DD} +0.3V	V
Storage Temperature	T _{STG}	-65 to 150	°C
Power Dissipation	P _D	Internally Limited	W
ESD Susceptibility	V _{ESD}	2000	V
Junction Temperature	T _{JMAX}	150	°C
Soldering Temperature (under 10 sec)	T _{SOLDER}	260	°C



DC ELECTRICAL CHARACTERISTICS (V_{DD}=5V, T_A=25°C)

PARAMETER	SYMBOL	TEST CONDITION	MIN.	TYP.	MAX.	UNIT
Power Supply Current	I _{DD}	V _{IN} = 0V, I _o = 0A, No Load	-	4.0	10.0	mA
		V _{IN} = 0V, I _o = 0A, 8Ω Load	-	5.0	15.0	mA
Shutdown Current	I _{SD}	V _{SHUTDOWN} = 0V	-	0.1	2.0	μA
Shutdown Voltage Input High	V _{SDIH}		1.2	-	-	V
Shutdown Voltage Input Low	V _{SDIL}		-	-	0.4	V
Output Offset Voltage	V _{OS}		-	7.0	50.0	mV
Resistor Output to GND	R _{OUT-GND}		7.0	8.5	9.7	kΩ
Output Power (8Ω)	P _o	THD = 2% (max), f = 1 kHz	-	1.0		W
Total Harmonic Distortion+ Noise	THD+N	P _o = 0.4 W _{rms} ; f = 1kHz	-	0.2		%
Power Supply Rejection Ratio	PSRR	V _{ripple} = 200mV sine p-p Input terminated with 10Ω to GND	-	57 (f = 217Hz) 66 (f = 1kHz)	-	dB
Wake-up time	T _{WU}		-	176		ms
Thermal Shutdown Temperature	T _{SD}		150	170	190	°C
Shut Down Time	T _{SdT}	8 Ω load		1.0		ms

DC ELECTRICAL CHARACTERISTICS (V_{DD}=3V, T_A=25°C)

PARAMETER	SYMBOL	TEST CONDITION	MIN.	TYP.	MAX.	UNIT
Power Supply Current	I _{DD}	V _{IN} = 0V, I _o = 0A, No Load	-	3.5	9.0	mA
		V _{IN} = 0V, I _o = 0A, 8Ω Load	-	4.5	14.0	mA
Shutdown Current	I _{SD}	V _{SHUTDOWN} = 0V	-	0.1	2.0	μA
Shutdown Voltage Input High	V _{SDIH}		1.2	-	-	V
Shutdown Voltage Input Low	V _{SDIL}		-	-	0.4	V
Output Offset Voltage	V _{OS}		-	7.0	50.0	mV
Resistor Output to GND	R _{OUT-GND}		7.0	8.5	9.7	kΩ
Output Power (8Ω)	P _o	THD = 1% (max), f = 1 kHz	0.28	0.31		W
Total Harmonic Distortion+ Noise	THD+N	P _o = 0.15 W _{rms} , f = 1kHz	-	0.1	-	%
Power Supply Rejection Ratio	PSRR	V _{ripple} = 200mV sine p-p Input terminated with 10Ω to GND	-	57 (f = 217Hz) 65 (f = 1kHz)	-	dB
Wake-up time	T _{WU}		-	114		ms
Thermal Shutdown Temperature	T _{SD}		150	170	190	°C

ORDERING INFORMATION

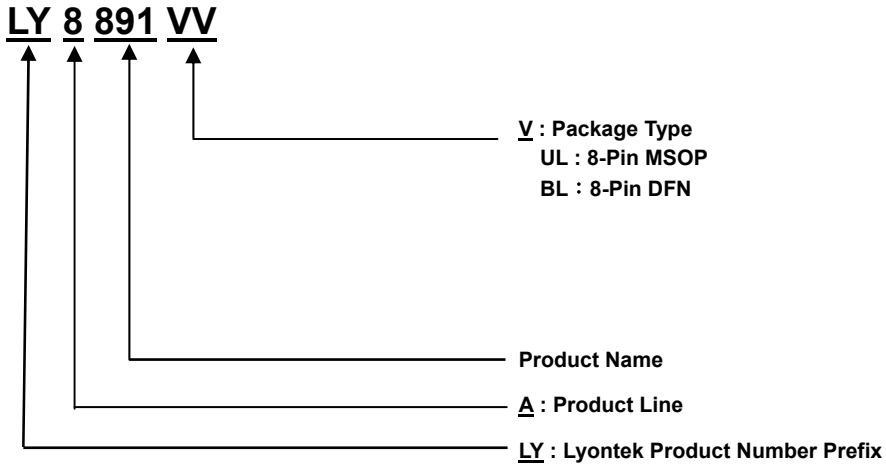

TYPICAL PERFORMANCE CHARACTERISTICS

Figure 3
THD+N vs Frequency
at $V_{DD}=5V$, $R_L=8\Omega$, $PWR=250mW$, $A_V=2$

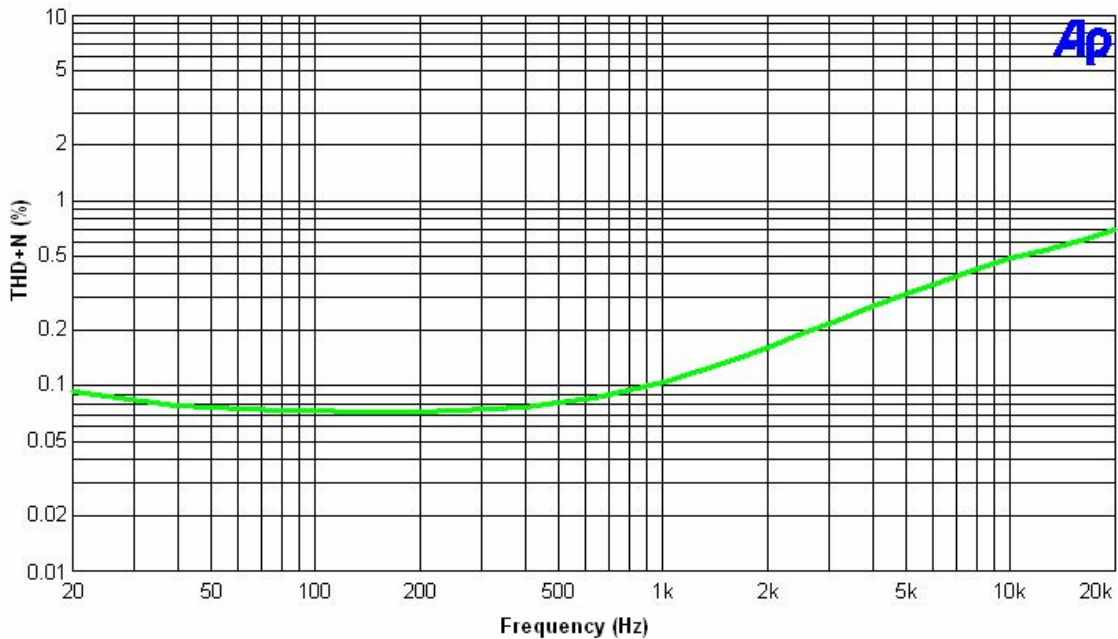

Figure 4
THD+N vs Frequency
 at $V_{DD}=3.3V$, $R_L=8\Omega$, $PWR=250mW$, $A_v=2$

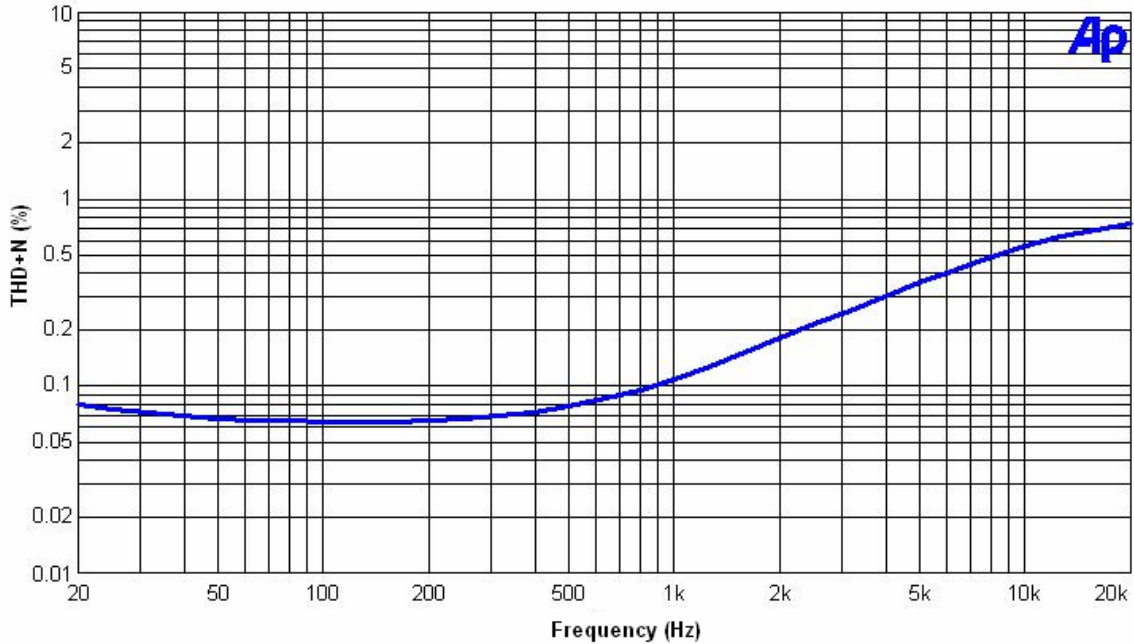

Figure 5
THD+N vs Frequency
 at $V_{DD}=3V$, $R_L=8\Omega$, $PWR=250mW$, $A_v=2$

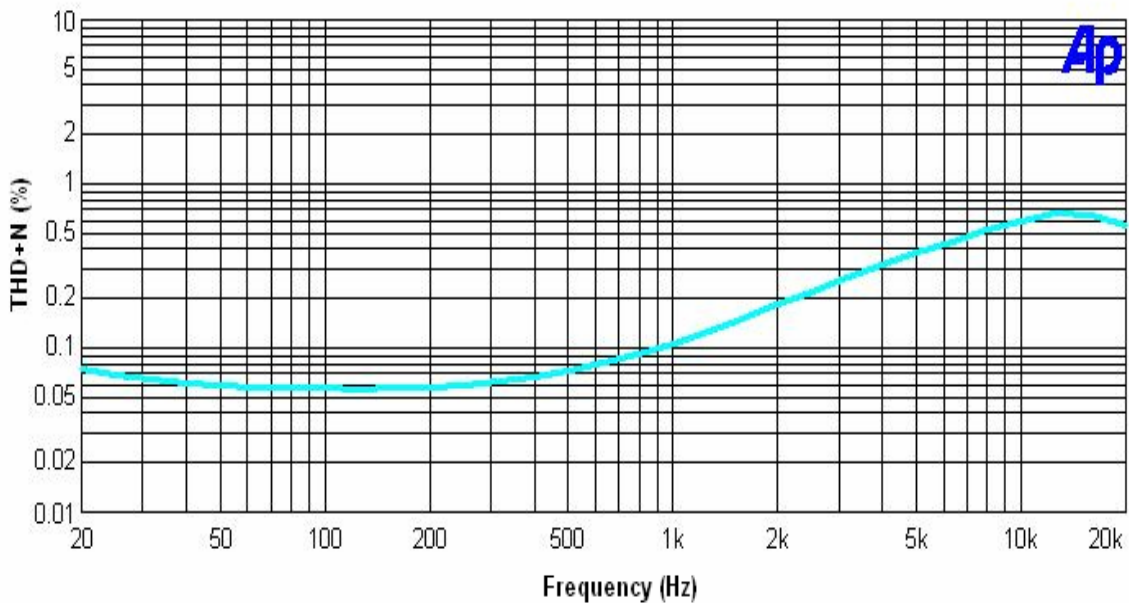

Figure 6
THD+N vs Frequency
 at $V_{DD}=2.6V$, $R_L=8\Omega$, $PWR=250mW$, $A_V=2$

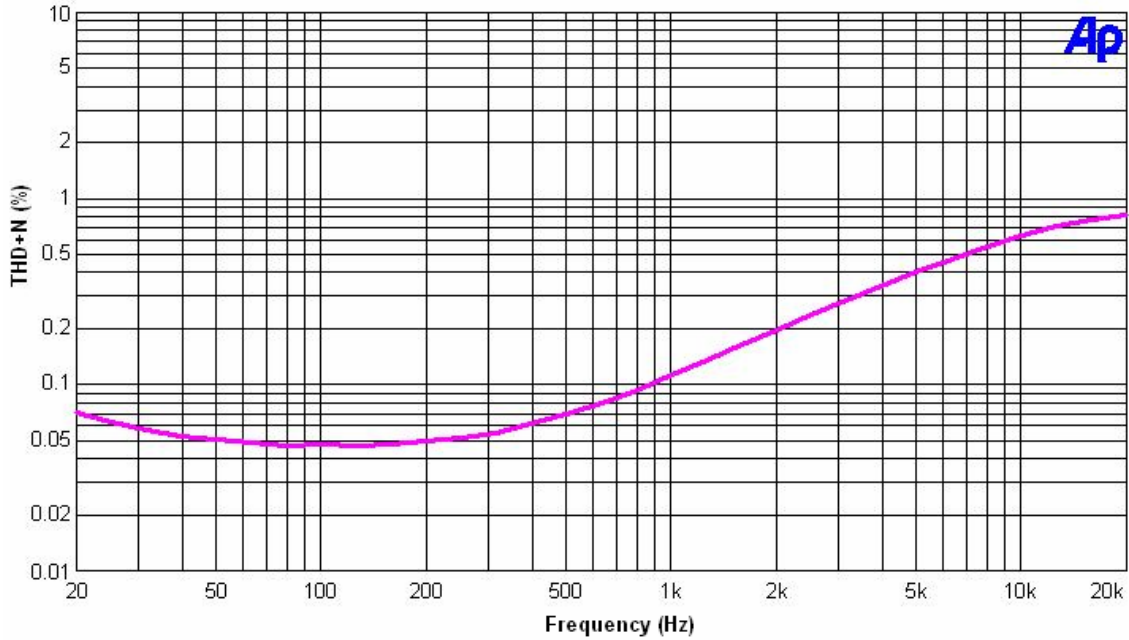

Figure 7
THD+N vs Frequency
 at $V_{DD}=2.6V$, $R_L=4\Omega$, $PWR=250mW$, $A_V=2$

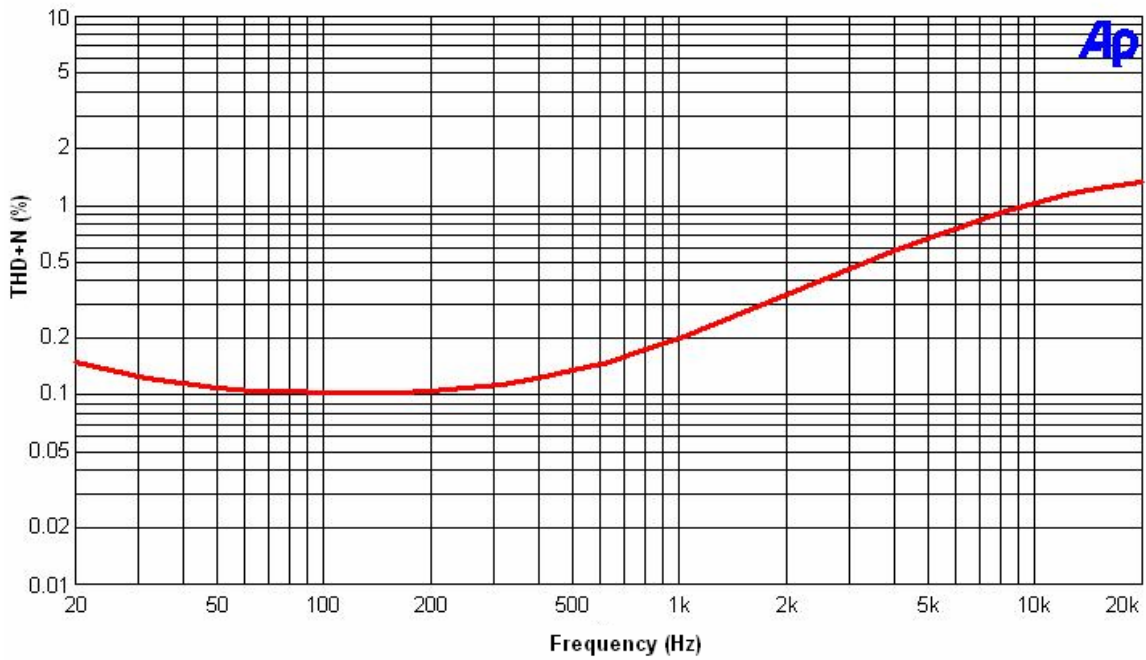

Figure 8
THD+N vs Power Out
@ VDD=5V, RL=8Ω, f=1kHz, Av=2

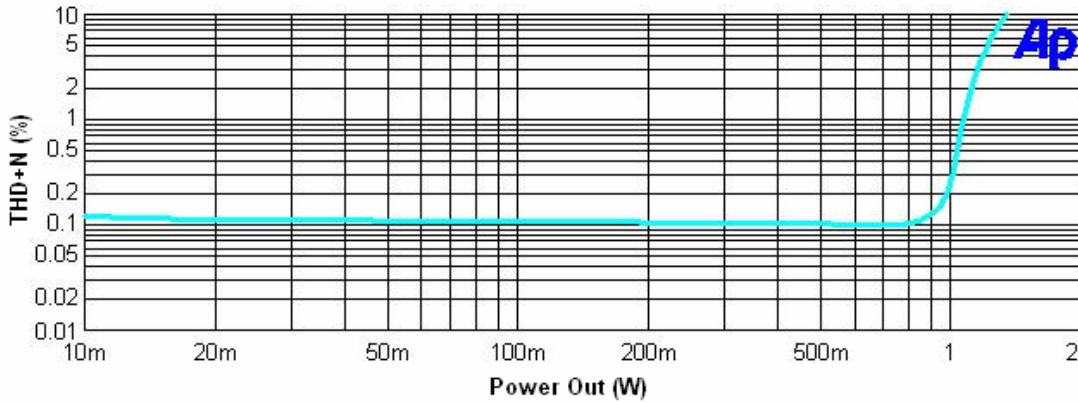

Figure 9
THD+N vs Power Out
@ VDD=3.3V, RL=8Ω, f=1kHz, Av=2

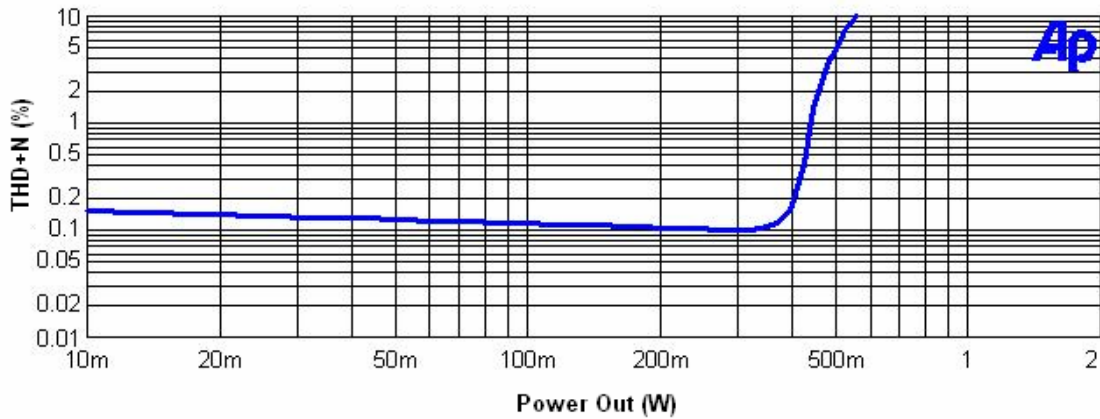

Figure 10
THD+N vs Power Out
@ VDD=3V, RL=8Ω, f=1kHz, Av=2

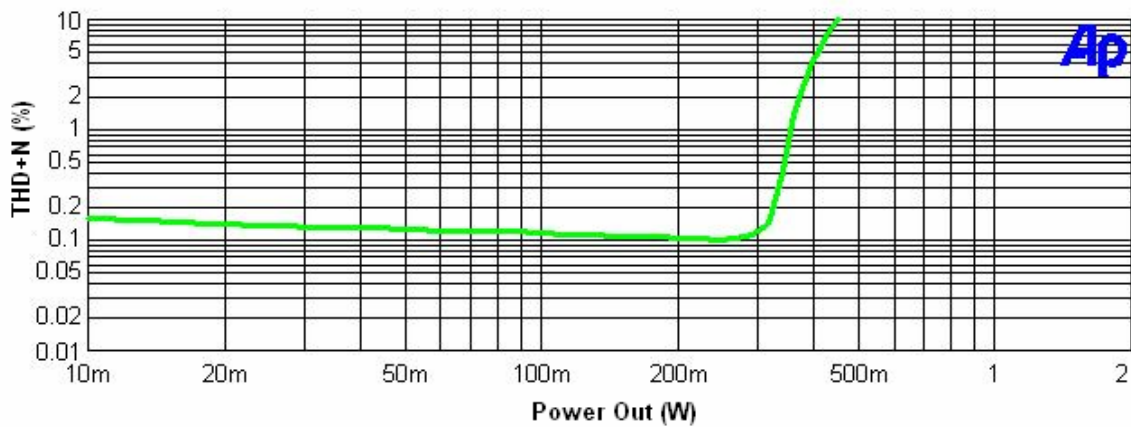



Figure 11
THD+N vs Power Out
@ VDD=2.6V, RL=8Ω, f=1kHz, Av=2

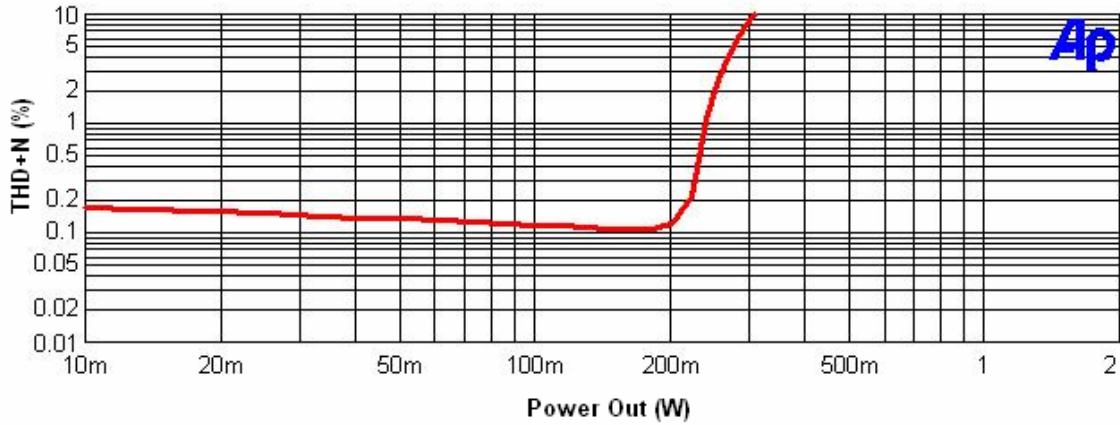

Figure 12
THD+N vs Power Out
@ VDD=2.6V, RL=4Ω, f=1kHz, Av=2

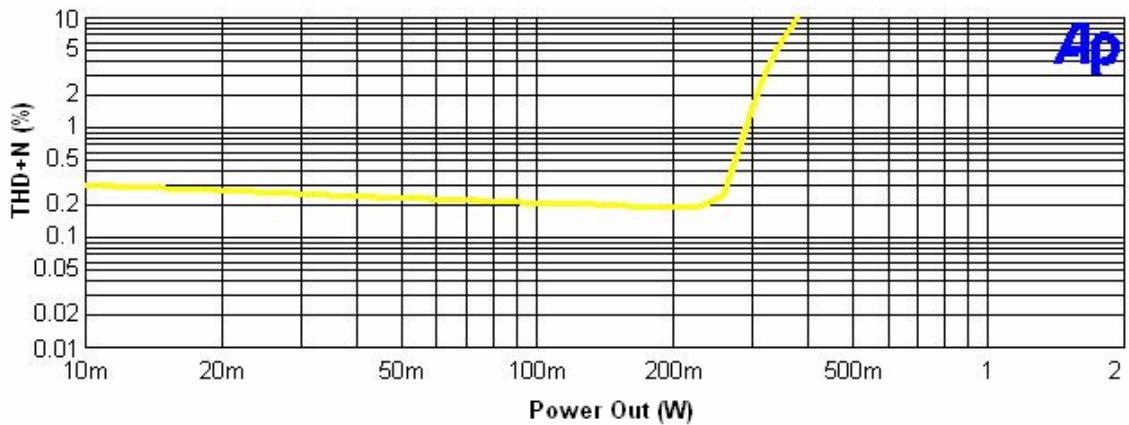

Figure 13
Power Supply Rejection Ratio (PSRR) @ Av=2
VDD=5V, V ripple =200mvp-p, RL=8Ω, RIN=Float

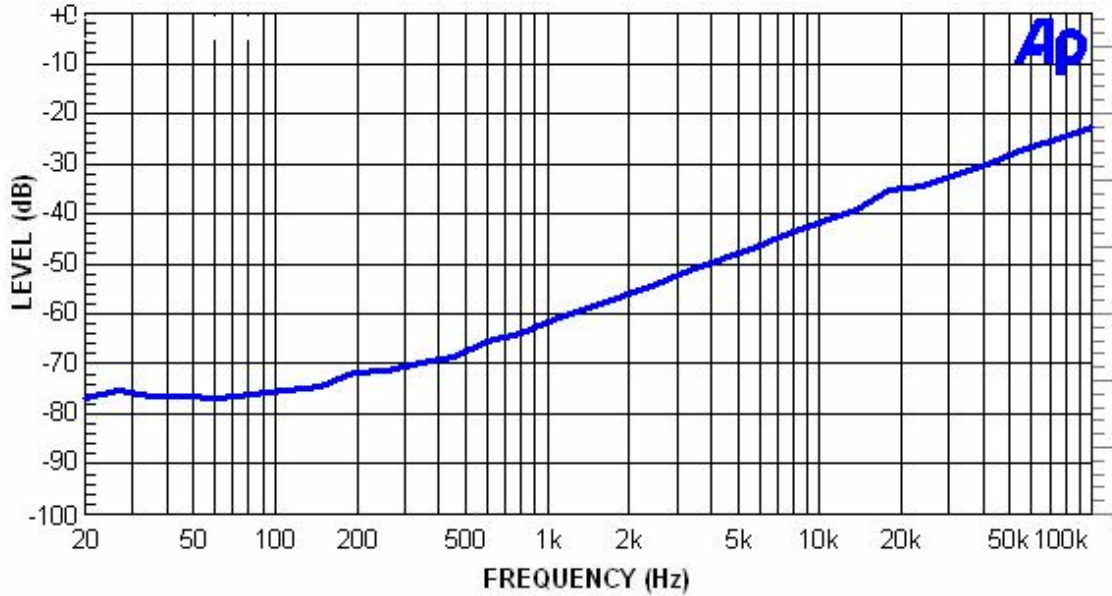

Figure 14
Power Supply Rejection Ratio (PSRR) @ Av=2
VDD=3V, V ripple =200mvp-p, RL=8Ω, RIN=Float

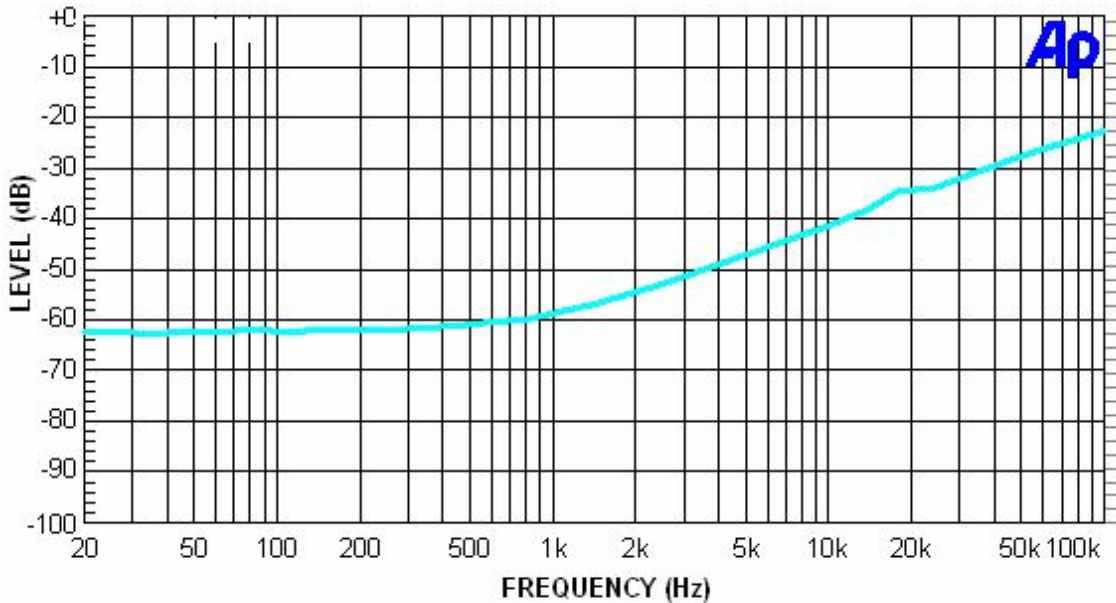

Figure 15
Power Supply Rejection Ratio (PSRR) @ Av=4
VDD=5V, V ripple =200mvp-p, RL=8Ω, RIN=Float

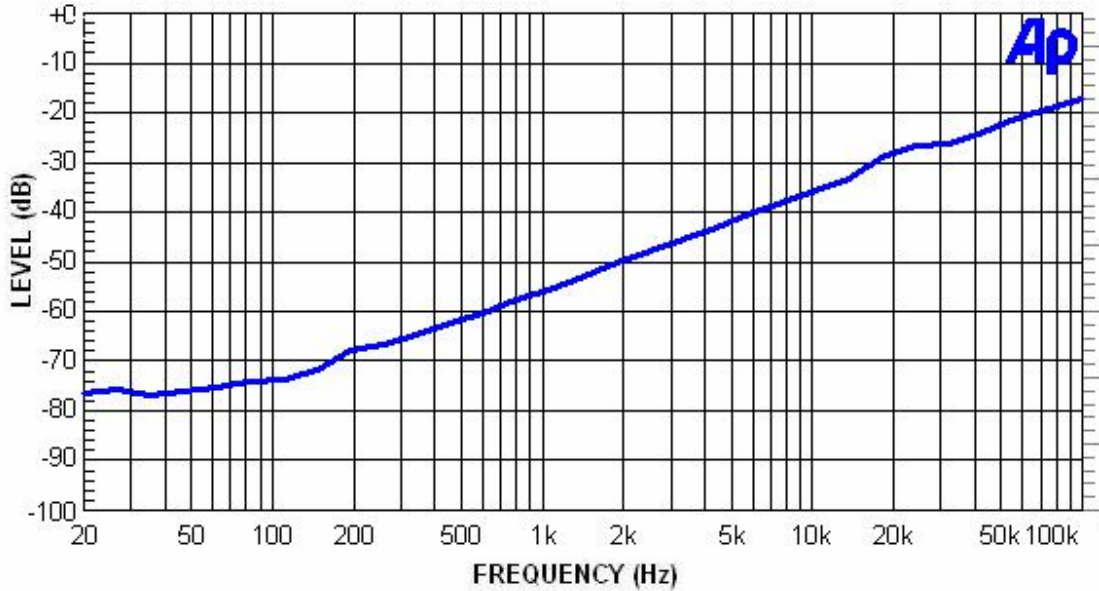

Figure 16
Power Supply Rejection Ratio (PSRR) @ Av=4
VDD=3V, V ripple =200mvp-p, RL=8Ω, RIN=Float

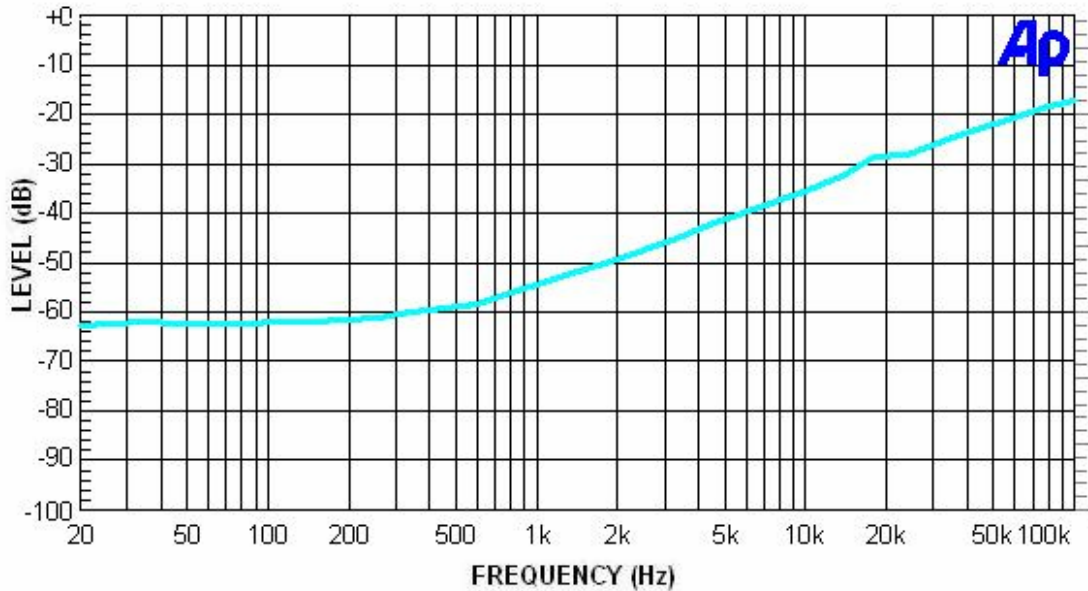

Figure 17
Power Supply Rejection Ratio (PSRR) @ Av=2
VDD=5V, V ripple =200mvp-p, RL=8Ω, RIN=10Ω

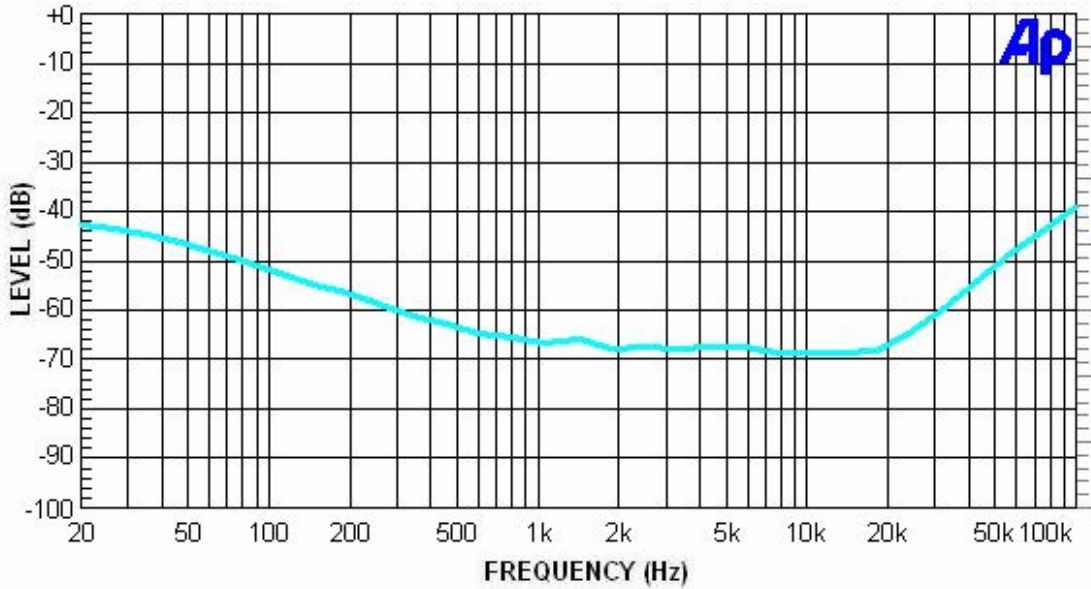

Figure 18
Power Supply Rejection Ratio (PSRR) @ Av=2
VDD=3V, V ripple =200mvp-p, RL=8Ω, RIN=10Ω

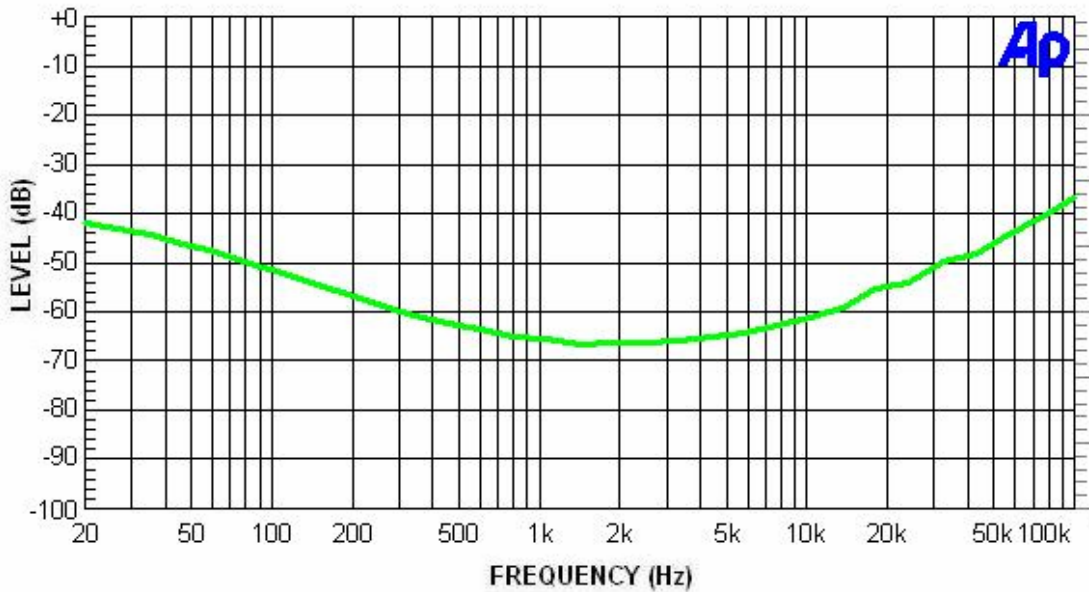

Figure 19
Power Supply Rejection Ratio (PSRR) @ Av=2
VDD=3.3V, V ripple =200mvp-p, RL=8Ω, RIN=10Ω

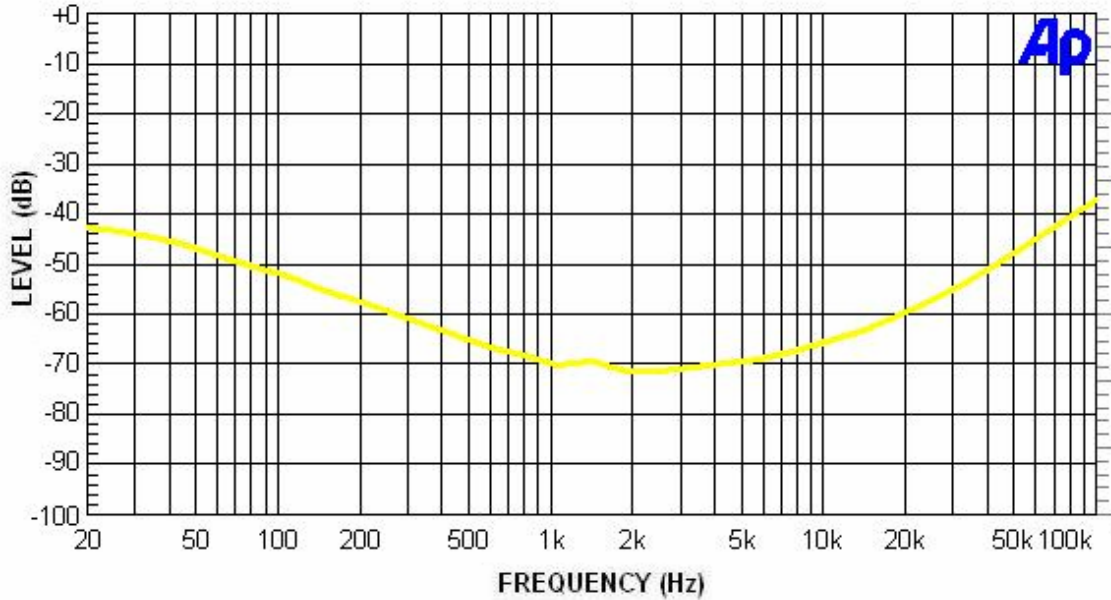

Figure 20
Power Supply Rejection Ratio (PSRR) @ Av=2
VDD=2.6V, V ripple =200mvp-p, RL=8Ω, RIN=10Ω

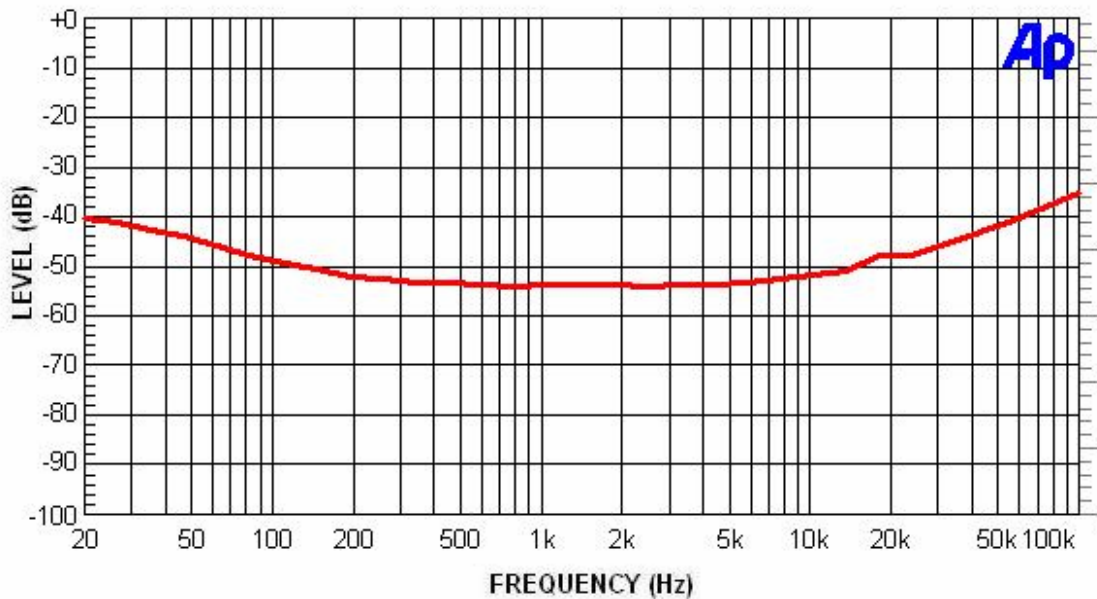

Figure 21
Power Supply Rejection Ratio (PSRR) @ Av=4
VDD=5V, V ripple =200mvp-p, RL=8Ω, RIN=10Ω

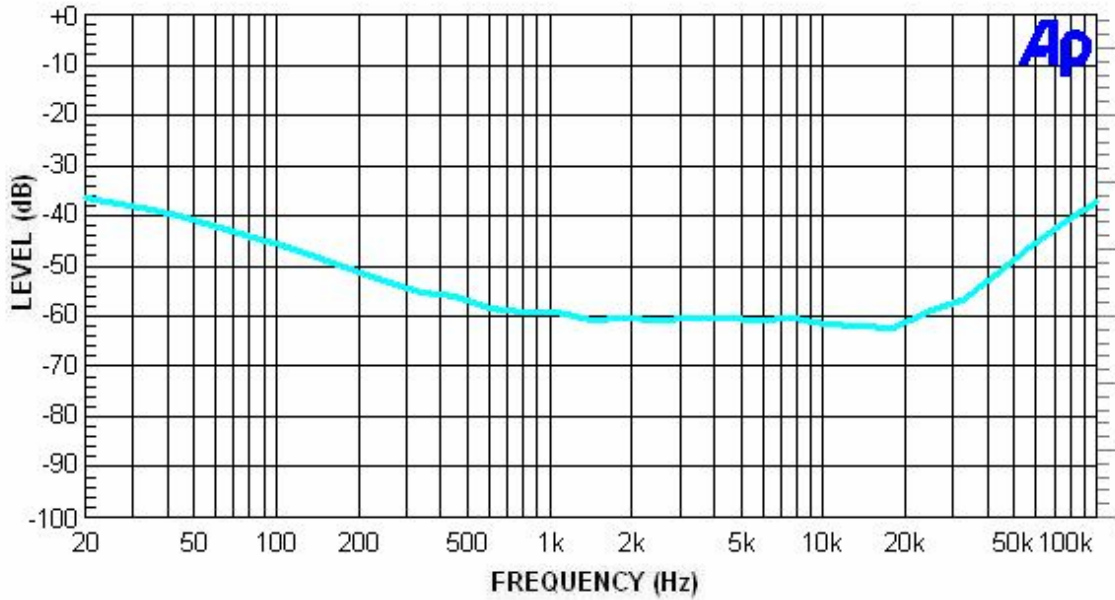
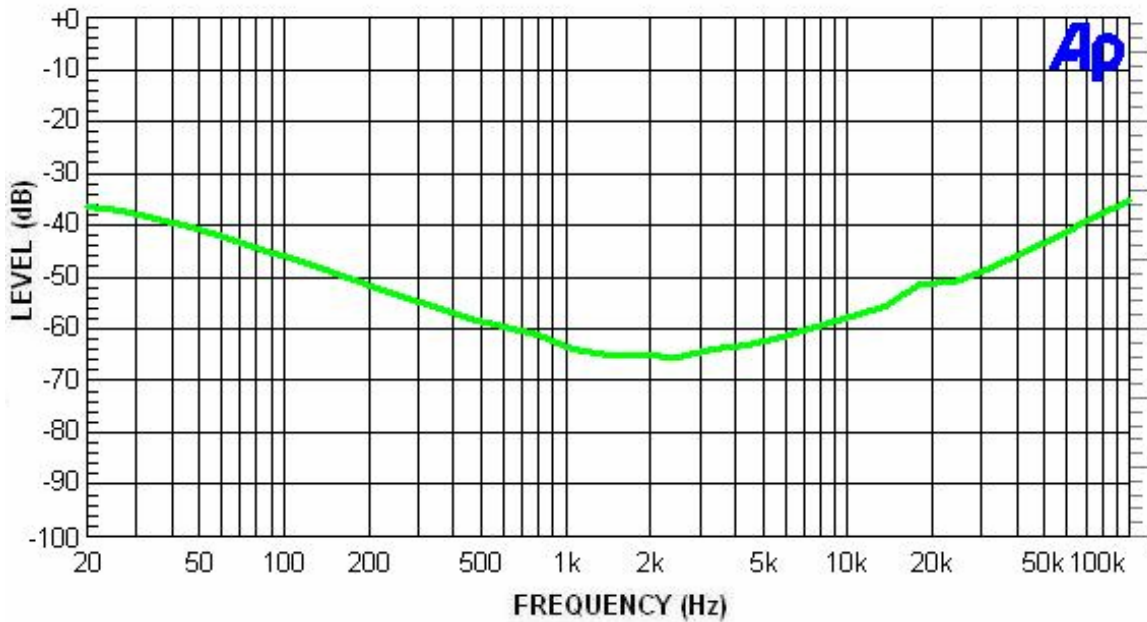

Figure 22
Power Supply Rejection Ratio (PSRR) @ Av=4
VDD=3V, V ripple =200mvp-p, RL=8Ω, RIN=10Ω



APPLICATION INFORMATION

BRIDGED CONFIGURATION EXPLANATION

As shown in Figure 1, the LY8891 has two operational amplifiers internally, allowing for a few different amplifier configurations. The first amplifier's gain is externally configurable, while the second amplifier is internally fixed in a unity-gain, inverting configuration. The closed-loop gain of the first amplifier is set by selecting the ratio of R_f to R_{IN} while the second amplifier's gain is fixed by the two internal 20kΩ resistors. *Figure 1* shows that the output of amplifier one serves as the input to amplifier two which results in both amplifiers producing signals identical in magnitude, but out of phase by 180°. Consequently, the differential gain for the IC is

$$AVD = 2 \times (R_f / R_{IN})$$

By driving the load differentially through outputs V_{o1} and V_{o2} , an amplifier configuration commonly referred to as "bridged mode" is established. Bridged mode operation is different from the classical single-ended amplifier configuration where one side of the load is connected to ground.

A bridge amplifier design has a few distinct advantages over the single-ended configuration, as it provides differential drive to the load, thus doubling output swing for a specified supply voltage. Four times the output power is possible as compared to a single-ended amplifier under the same conditions.

This increase in attainable output power assumes that the amplifier is not current limited or clipped. In order to choose an amplifier's closed-loop gain without causing excessive clipping, please refer to the Audio Power Amplifier Design section.

A bridge configuration, such as the one used in the LY8891, also creates a second advantage over single-ended amplifiers. Since the differential outputs, V_{o1} and V_{o2} , are biased at half-supply, no net DC voltage exists across the load. This eliminates the need for an output coupling capacitor which is required in a single supply, single-ended amplifier configuration. Without an output coupling capacitor, the half-supply bias across the load would result in both increased internal IC power dissipation and also possible loudspeaker damage.

Power Dissipation

Power dissipation is a major concern when designing a successful amplifier, whether the amplifier is bridged or single-ended. A direct consequence of the increased power delivered to the load by a bridge amplifier is an increase in internal power dissipation. Since the LY8891 has two operational amplifiers in one package, the maximum internal power dissipation is 4 times that of a single-ended amplifier. The maximum power dissipation for a given application can be derived from the power dissipation graphs of from equation 1.

$$P_{DMAX} = 4 \times (V_{DD})^2 / (2 \pi^2 R_L) \dots\dots\dots(1)$$

It is critical that the maximum junction temperature T_{JMAX} of 150°C is not exceeded. T_{JMAX} can be determined from the power derating curves by using P_{DMAX} and the PC board foil area. By adding additional copper foil, the thermal resistance of the application can be reduced, resulting in higher P_{DMAX} . Additional copper foil can be added to any of the leads connected to the LY8891. If T_{JMAX} still exceeds 150°C, then additional changes must be made. These changes can include reduced supply voltage, higher load impedance, or reduced ambient temperature. Internal power dissipation is a function of output power.

POWER SUPPLY BYPASSING

As with any amplifier, proper supply bypassing is critical for low noise performance and high power supply rejection. The capacitor location on both the bypass and power supply pins should be as close to the device as possible.

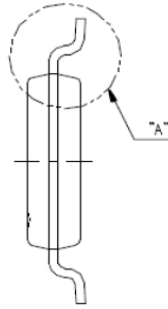
PACKAGE OUTLINE DIMENSION
8 pin 25.6 mil MSOP Package Outline Dimension

SYMBOLS	MIN.	NOM.	MAX.
A	—	—	1.10
A1	0.00	—	0.15
A2	0.75	0.85	0.95
D	3.00 BSC		
E	4.90 BSC		
E1	3.00 BSC		
L	0.40	0.60	0.80
L1	0.95 REF		
θ°	0	—	8

UNIT : MM

NOTES:

- JEDEC OUTLINE : MO-187 AA
- DIMENSION 'D' DOES NOT INCLUDE MOLD FLASH, PROTRUSIONS OR GATE BURRS. MOLD FLASH, PROTRUSIONS OR GATE BURRS SHALL NOT EXCEED 0.15 PER SIDE.
- DIMENSION 'E1' DOES NOT INCLUDE INTERLEAD FLASH OR PROTRUSION. INTERLEAD FLASH OR PROTRUSION SHALL NOT EXCEED 0.25 PER SIDE.
- DIMENSION '0.22' DOES NOT INCLUDE DAMBAR PROTRUSION. ALLOWABLE DAMBAR PROTRUSION SHALL BE 0.08 MM TOTAL IN EXCESS OF THE '0.22' DIMENSION AT MAXIMUM MATERIAL CONDITION. DAMBAR CANNOT BE LOCATED ON THE LOWER RADIUS OF THE FOOT. MINIMUM SPAC BETWEEN PROTRUSION AND ADJACENT LEAD IS 0.07 MM.
- DIMENSIONS 'D' AND 'E1' TO BE DETERMINED AT DATUM PLANE \square .

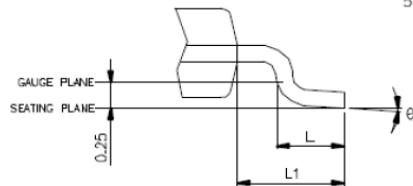
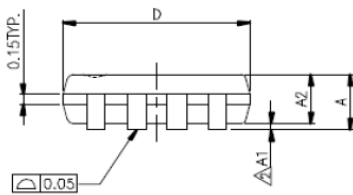

8 Pin DFN Package Outline Dimension

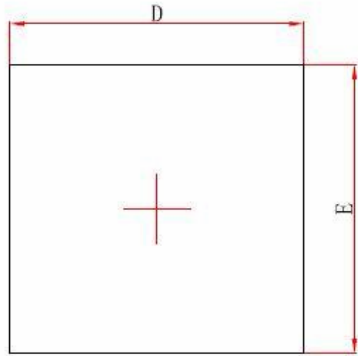

Top View

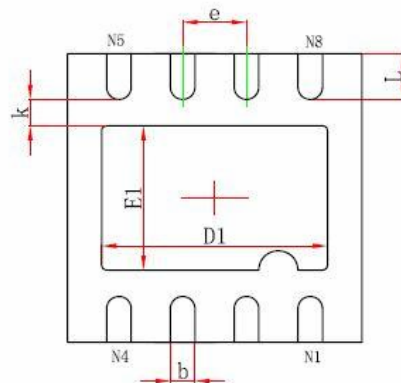

Bottom View

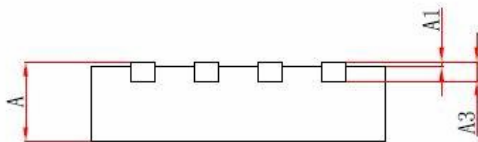

Side View

Symbol	Dimensions In Millimeters	
	Min.	Max.
A	0.700/0.800	0.800/0.900
A1	0.000	0.050
A3	0.203REF.	
D	2.900	3.100
E	2.900	3.100
D1	2.200	2.400
E1	1.400	1.600
k	0.200MIN.	
b	0.180	0.300
e	0.650TYP.	
L	0.375	0.575